

Initial graph:

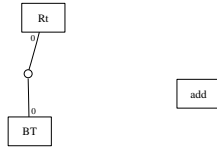

BT 1 rule:

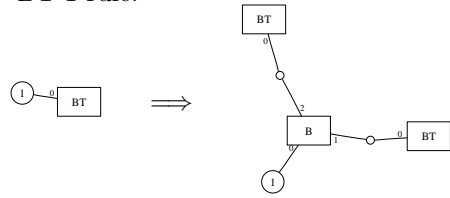

RT rule:

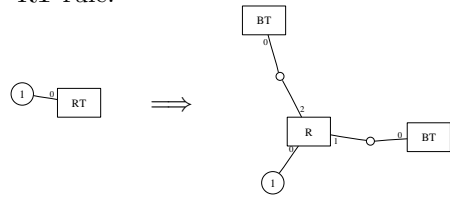

BT leaf rule:

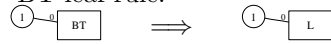

BT 2 rule:

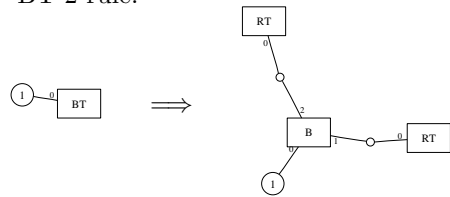

BT 3 rule:

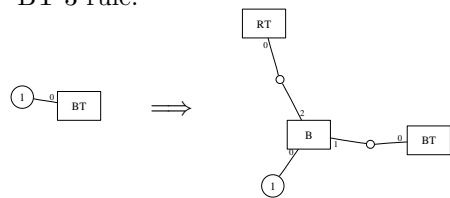

---

BT 4 rule:

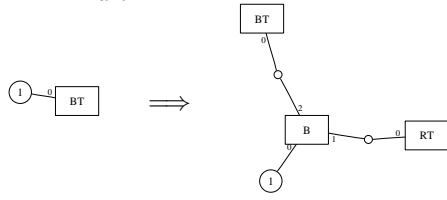

---

add leaf:

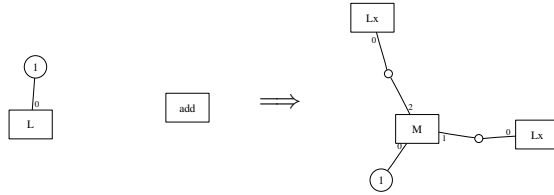

---

marker black 1:

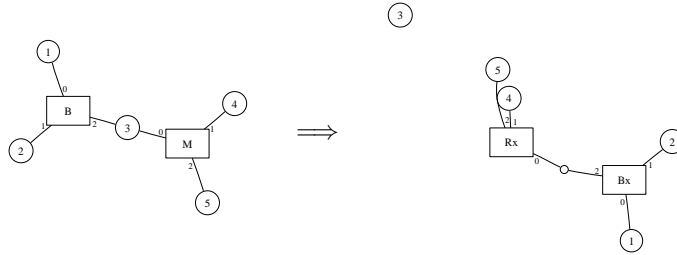

---

marker black 2:

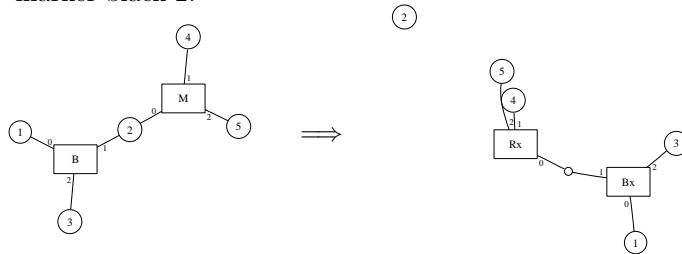

---

marker red 1:

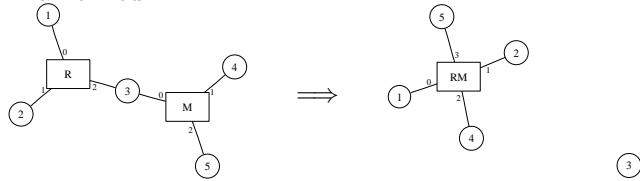

---

marker red 2:

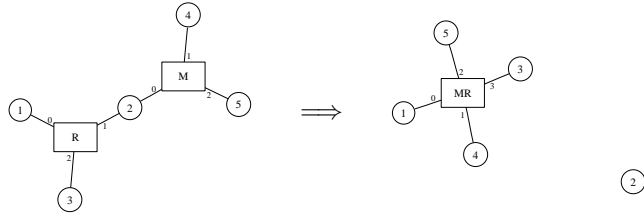

---

black red 1:

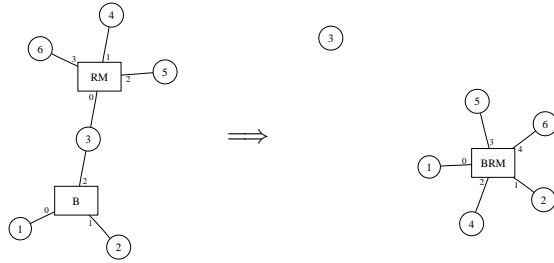

---

black red 2:

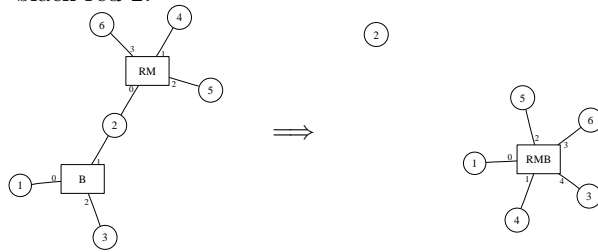

---

black red 3:

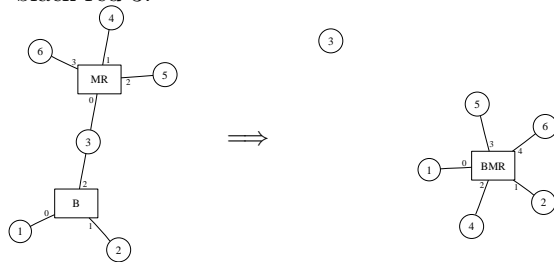

black red 4:

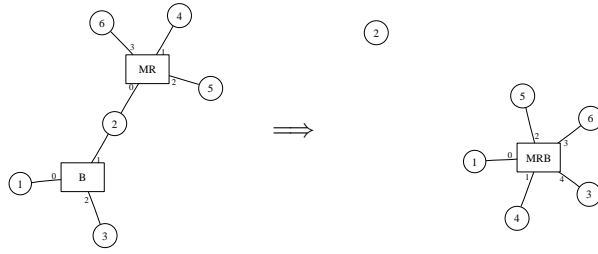

flip 1:

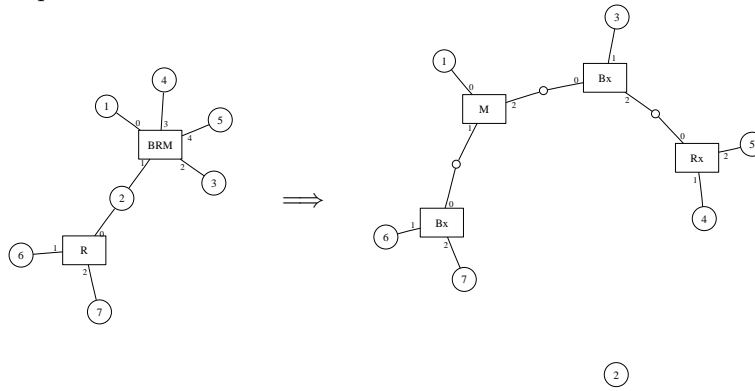

flip 2:

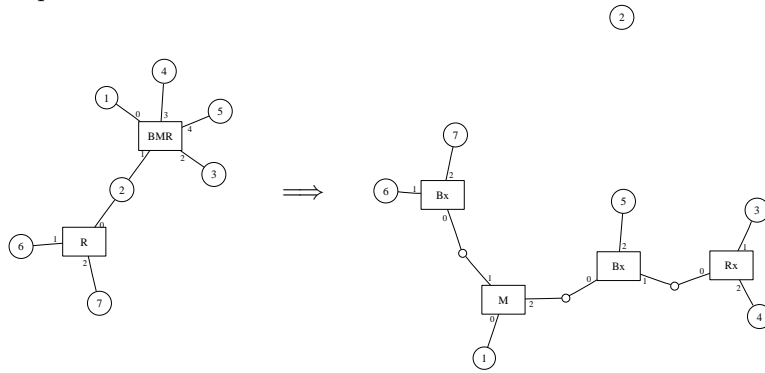

flip 3:

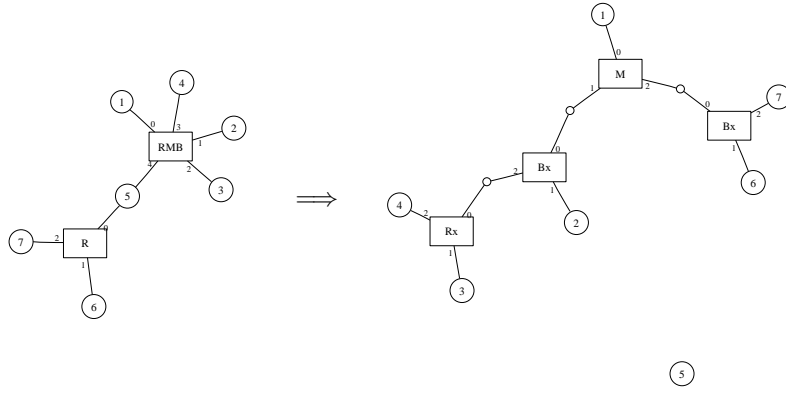

flip 4:

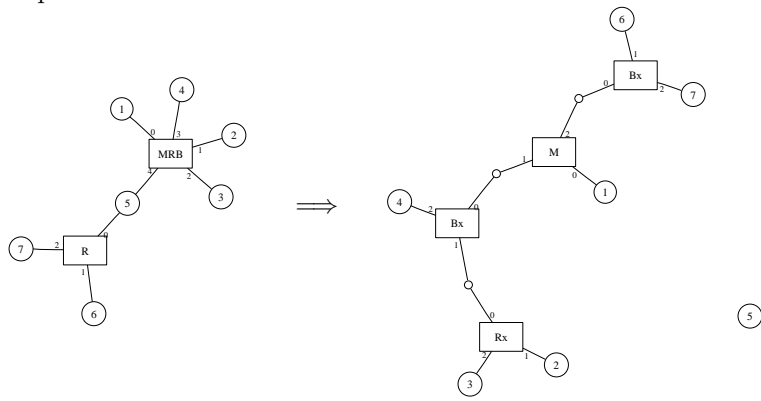

rotate 1:

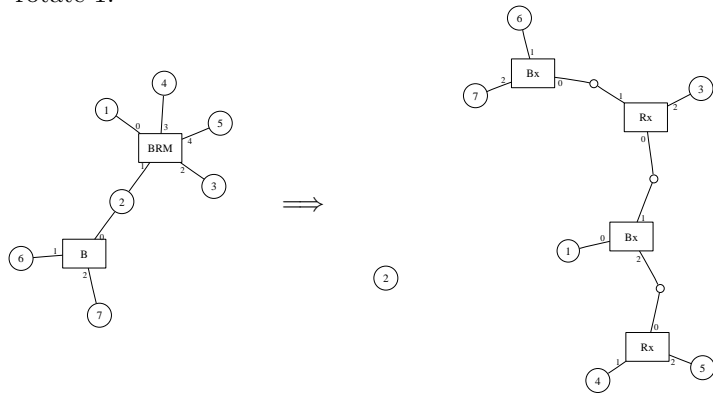

rotate 2:

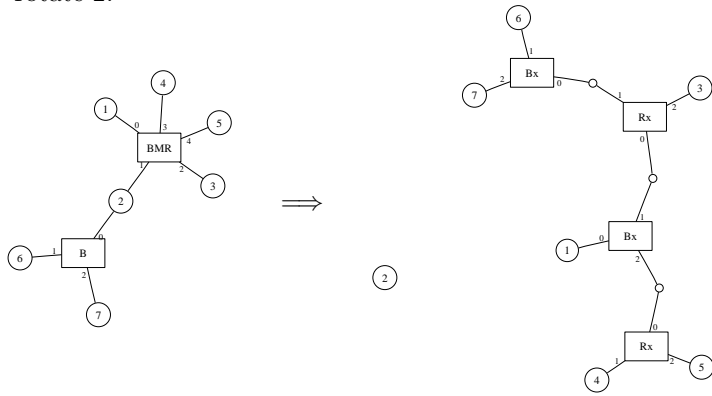

rotate 3:

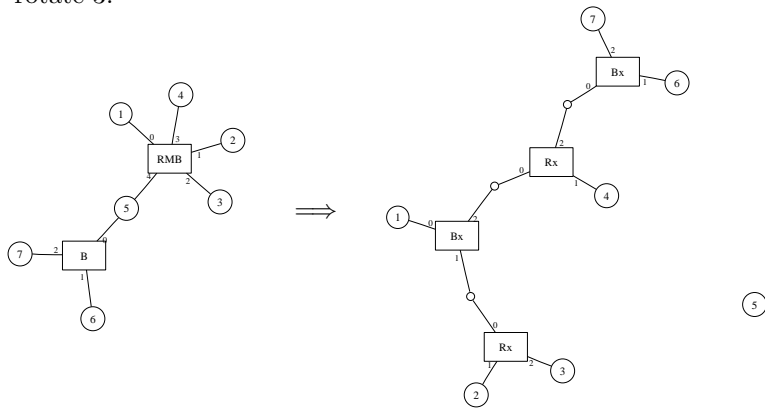

rotate 4:

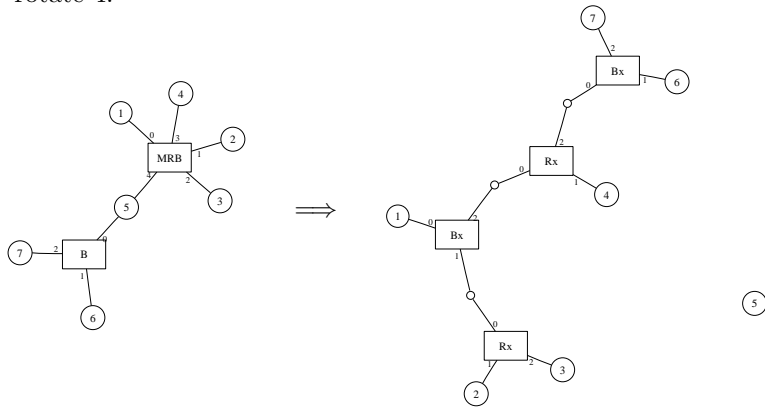

marker root:

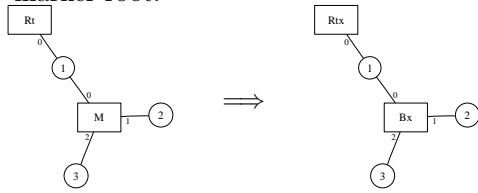

rotate leaf 1:

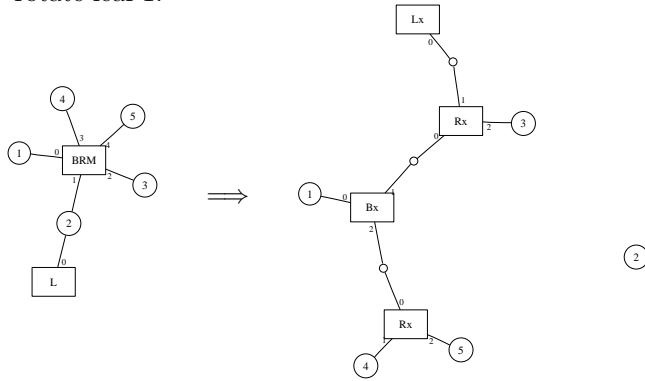

rotate leaf 2:

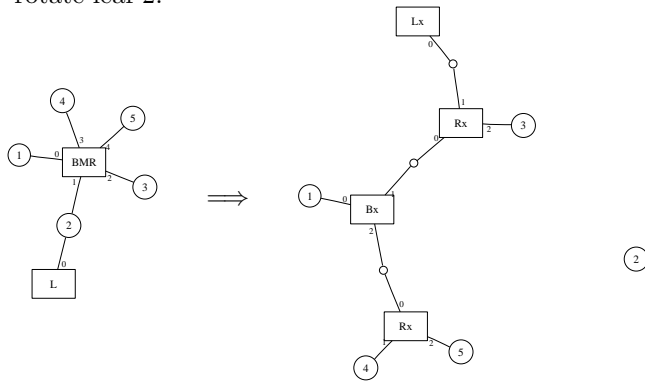

rotate leaf 3:

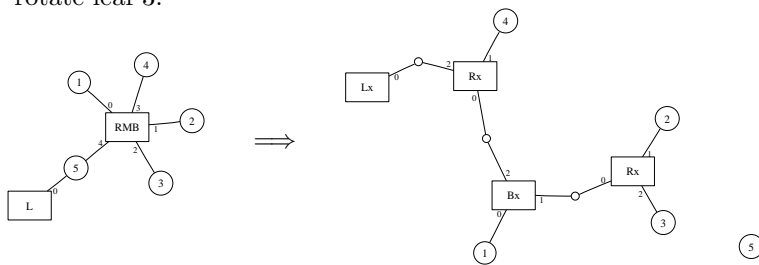

---

rotate leaf 4:

